



JAG

german power actuatos since 2012

JAG-EASY-BOX INNOVATIVE TECHNIK

- **easymatic:** Selbststellende Betätiger
- **easymount:** Direktmontage in < 5 Sek.
- **easyclick:** Deckel mit schneller Schließung
- **easyconnect:** Elektrischer Anschluss < 2 Sek.
- **easyoptic:** Große optische Anzeige 0-360°
- **easytask:** Für Bohrbilder 80x30, ...
- **easywire:** Magnetventileanschluss in Box enthalten
- **easyled:** Mit LED-Technologie (rot oder grün)

JAG-EASY-BOX INNOVATIVE TECHNIC

- **easymatic:** Self-adjusting cams
- **easymount:** Mounting in < 5 sec.
- **easyclick:** Superfast locking of cover
- **easyconnect:** Electrical connection < 2 sec.
- **easyoptic:** Big visual indicator 0-360°
- **easytask:** For holespacing 80x30, ...
- **easywire:** Solenoid connection in box
- **easyled:** With LED-technology (red or green)

JAG-EASY-BOX TECNICA INNOVATIVA

- **easymatic:** Camme autoregolanti
- **easymount:** Montaggio in < 5 sec.
- **easyclick:** Coperchio con chiusura veloce
- **easyconnect:** Connessione elettrica in < 2 sec.
- **easyoptic:** Indicatore visuale grande 0-360°
- **easytask:** Per foratura 80x30, ...
- **easywire:** Connessione elettrovalvola in box
- **easyled:** Con tecnologia LED (rosso o verde)

ABMESSUNGEN

DIMENSIONS

DIMENSIONI

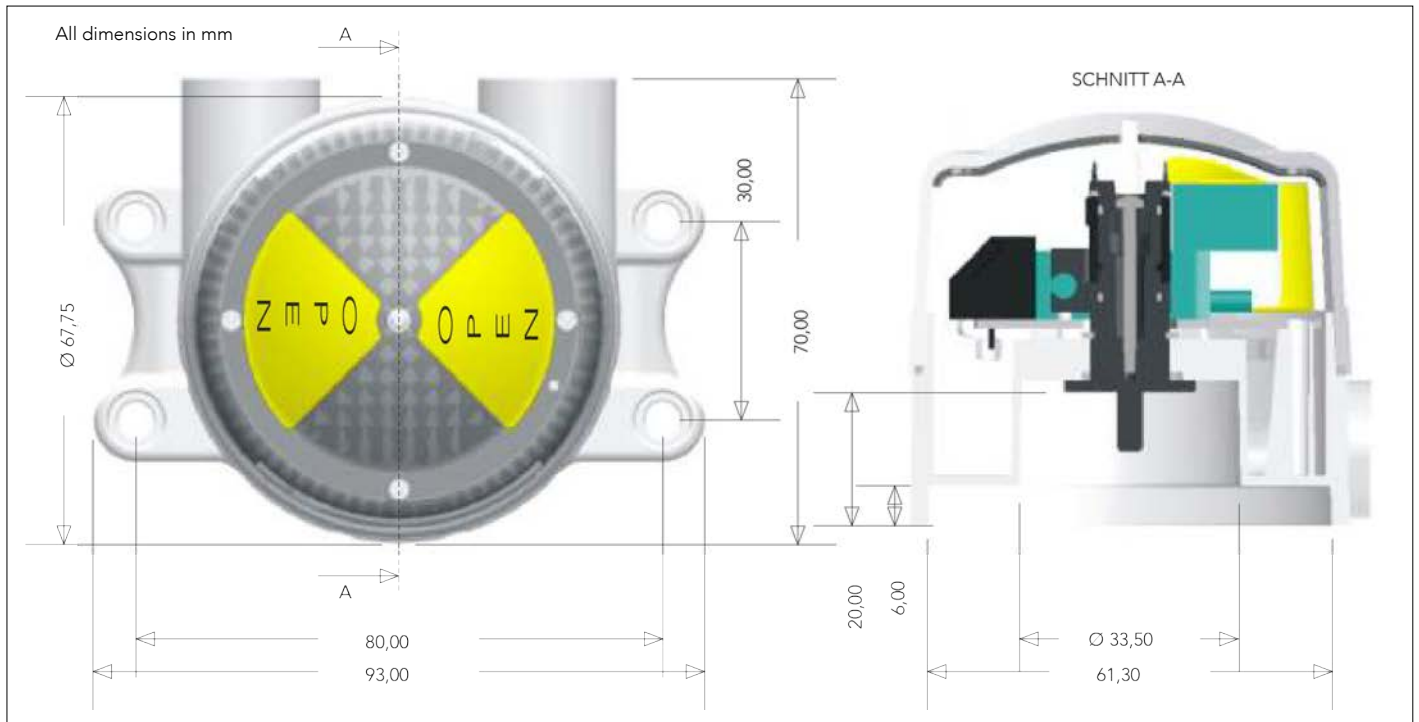

Box mit Kabelverschraubung und Klemmleiste
Box with cable gland and terminal block
Box con pressacavo e morsetti

= **ECOLINE**

JAG-EASY-BOX SCHALTER





Die ecoline Ausführung ist die preiswerteste Ausstattungslinie der easybox und umfasst: Box mit Kabelverschraubung - Elektrischer Anschluss erfolgt über Klemmleisten in der Box.

JAG-EASY-BOX SWITCHES

The ecoline execution is the most economic execution line of the easybox and includes: Box with cable gland - Electric wiring on terminal blocks in the switchbox.

JAG-EASY-BOX FINECORSA

L'esecuzione ecoline è la più economica versione dell'easybox e comprende: Box con pressacavo - Connessione elettrica avviene tramite le morsettiere nel box.

Endschalter Nr. Switch No. Finecorsa no.	Hersteller Producer Produttore	Typ Type Tipo	Anz. Leiter No. wires No. fili	Funktion Function Funzione	Spannung Tension Tensione	Temperatur Temperature Temperatura	Zulassungen Approvals Ammissioni	Artikel-Nr. Item number Codice art.	Euro
 -101	ZIPPY DF3 silver contacts	Mechanisch Mechanical Meccanico	3	NC / NO	3A 125/250VAC 24VDC	0 ... +55°C	UL-ENEC	JEB2M101-E	
 -102	ZIPPY SM1 silver contacts	Mechanisch Mechanical Meccanico	3	NC / NO	6A 125/250VAC 24VDC	-25 ... +85°C	UL-ENEC	JEB2M102-E	
 -14	CROUZET 83181 gold contacts	Mechanisch Mechanical Meccanico	3	NC / NO	24 - 240 V	-40 ... +125°C	ATEX 3D UL-cUL (on request)	JEB2M14-E	
 -31	IFM IS5001 = IS5075	Induktiv Inductive Induttivo	3	PNP NO	10 - 36V DC	-25 ... +80°C	cULus	JEB2I31-E	
 -39	IFM IS5002	Induktiv Inductive Induttivo	2	PNP NO	10 - 36V DC	-25 ... +80°C	cULus	JEB2I39-E	
 -32	IFM IS5026 = IS5076	Induktiv Inductive Induttivo	2	PNP / NPN NC / NO programmable	5 - 36 V DC	-25 ... +80°C	cULus	JEB2I32-E	
 -33	IFM NS5002	Induktiv Inductive Induttivo	2	NAMUR NC	8.2V DC (EX) 7.5 - 30V DC (nEX)	-20 ... +70°C	cCSAus FM IECEX ATEX 2G/1D	JEB2I33-E-IA	
 -324	IFM N7S21A	Schlitzinitiator Slot sensor A fessura	2	NAMUR NC	8.2V DC (EX) 5 - 25V DC (nEX)	-40 ... +100°C	IECEX ATEX 1GD	JEB2S324-E-IA	
 -21	P+F NBB2-V3-E2	Induktiv Inductive Induttivo	3	PNP NO	10 - 30V DC	-25 ... +70°C	cULus cCSAus CCC (<=36V)	JEB2I21-E	
 -27	P+F NBB2-V3-E0	Induktiv Inductive Induttivo	3	NPN NO	10 - 30V DC	-25 ... +70°C	cULus cCSAus CCC (<=36V)	JEB2I27-E	
 -251	P+F NBB2-V3-E2-3G-3D	Induktiv Inductive Induttivo	3	PNP NO	10 - 30V DC	-25 ... +70°C	ATEX 3GD cULus-cCSAus CCC (<=36V)	JEB2I251-E	
 -285	P+F NBB2-V3-E3	Induktiv Inductive Induttivo	3	PNP NC	10 - 30V DC	-25 ... +70°C	cULus cCSAus CCC (<=36V)	JEB2I285-E	
 -	P+F NBB2-V3-Z4	Induktiv Inductive Induttivo	2	NO	5-60V DC	-25 ... +70°C	cULus cCSAus CCC	JEB2I28-E	
 -22	P+F NCB2-V3-N0	Induktiv Inductive Induttivo	2	NAMUR NC	8.0V DC	-25 ... +100°C	ATEX 1GD cULus-cCSAus CCC (<=36V)	JEB2I22-E-IA	
 -221	P+F SB3,5-E2	Schlitzinitiator Slot sensor A fessura	3	PNP NO	10 - 30V DC	-25 ... +70°C	cULus cCSAus CCC (<=36V)	JEB2S221-E	
 -24	P+F SC3,5-G-N0	Schlitzinitiator Slot sensor A fessura	2	NAMUR NC	8.2V DC (EX) 5 - 25V DC (nEX)	-25 ... +100°C	ATEX 1GD cULus-cCSAus CCC (<=36V)	JEB2S24-E-IA	
 -236	P+F SJ3,5-SN	Schlitzinitiator Slot sensor A fessura	2	NAMUR NC	8.0V DC	-50 ... +100°C	ATEX 1GD cULus-cCSAus CCC (<=36V)	JEB2S236-E-IA	
 -225	P+F SJ3,5-S1N	Schlitzinitiator Slot sensor A fessura	2	NAMUR NO	8.0V DC	-25 ... +100°C	ATEX 1GD cULus-cCSAus CCC (<=36V)	JEB2S225-E-IA	



JAG

german power actuatos since 2012

JAG-EASY-BOX SCHALTER

Die highline Ausführung ist eine besonders bedienerfreundliche Ausstattungslinie der easybox: Box mit M12-er Flanschstecker, Konfektionierbare M12-er gewinkelte Kabeldose serienmäßig mitgeliefert.

Elektrischer Anschluss erfolgt über Stecker:

- Die Box muss nie geöffnet werden.
- Große Zeitersparnis bei Wartungsarbeiten.

JAG-EASY-BOX SWITCHES

The highline execution is a most operator-friendly execution line of the easybox and includes: Box with M12 male connector, field attachable M12 female angled connector is art of the standard equipment.

Electric wiring by standardized connector:

















- It is never needed to open switchbox.
- Big saving of time for service operation.

JAG-EASY-BOX FINECORSA

L'esecuzione highline è una versione dell'easybox molto apprezzabile per l'operatore: Box con connettore maschio M12, connettore angolato femmina da cablare M12 fa parte del corredo standard

Connessione elettrica tramite connettore:

- Non serve mai aprire il box
- Risparmio di tempo per manutenzioni

Endschalter Nr. Switch No. Finecorsa no.	Hersteller Producer Produttore	Type Tipo	Anz. Leiter No. wires No. fili	Funktion Function Funzione	Spannung Tension Tensione	Temperatur Temperature Temperatura	Zulassungen Approvals Ammissioni	Artikel-Nr. Item number Codice art.	Euro
 -101	ZIPPY DF3 silver contacts	Mechanisch Mechanical Meccanico	3	NC / NO	3A 125/250VAC 24VDC	0 ... +55°C	UL-ENEC	JEB2M101-H	
 -102	ZIPPY SM1 silver contacts	Mechanisch Mechanical Meccanico	3	NC / NO	6A 125/250VAC 24VDC	-25 ... +85°C	UL-ENEC	JEB2M102-H	
 -14	CROUZET 83181 gold contacts	Mechanisch Mechanical Meccanico	3	NC / NO	24 - 240 V	-40 ... +125°C	ATEX 3D UL-cUL (on request)	JEB2M14-H	
 -31	IFM IS5001 = IS5075	Induktiv Inductive Induttivo	3	PNP NO	10 - 36V DC	-25 ... +80°C	cULus	JEB2I31-H	
 -39	IFM IS5002	Induktiv Inductive Induttivo	2	PNP NO	10 - 36V DC	-25 ... +80°C	cULus	JEB2I39-H	
 -32	IFM IS5026 = IS5076	Induktiv Inductive Induttivo	2	PNP / NPN NC / NO programmable	5 - 36 V DC	-25 ... +80°C	cULus	JEB2I32-H	
 -33	IFM NS5002	Induktiv Inductive Induttivo	2	NAMUR NC	8.2V DC (EX) 7.5 - 30V DC (nEX)	-20 ... +70°C	cCSAus FM IECEX ATEX 2G/1D	JEB2I33-H-IA	
 -324	IFM N7S21A	Schlitzinitiator Slot sensor A fessura	2	NAMUR NC	8.2V DC (EX) 5 - 25V DC (nEX)	-40 ... +100°C	IECEX ATEX 1GD	JEB2S324-H-IA	
 -21	P+F NBB2-V3-E2	Induktiv Inductive Induttivo	3	PNP NO	10 - 30V DC	-25 ... +70°C	cULus cCSAus CCC (<=36V)	JEB2I21-H	
 -27	P+F NBB2-V3-E0	Induktiv Inductive Induttivo	3	NPN NO	10 - 30V DC	-25 ... +70°C	cULus cCSAus CCC (<=36V)	JEB2I27-H	
 -251	P+F NBB2-V3-E2- 3G-3D	Induktiv Inductive Induttivo	3	PNP NO	10 - 30V DC	-25 ... +70°C	ATEX 3GD cULus-cCSAus CCC (<=36V)	JEB2I251-H	
 -285	P+F NBB2-V3-E3	Induktiv Inductive Induttivo	3	PNP NC	10 - 30V DC	-25 ... +70°C	cULus cCSAus CCC (<=36V)	JEB2I285-H	
 -22	P+F NCB2-V3-N0	Induktiv Inductive Induttivo	2	NAMUR NC	8.0V DC	-25 ... +100°C	ATEX 1GD cULus-cCSAus CCC (<=36V)	JEB2I22-H-IA	
 -221	P+F SB3,5-E2	Schlitzinitiator Slot sensor A fessura	3	PNP NO	10 - 30V DC	-25 ... +70°C	cULus cCSAus CCC (<=36V)	JEB2S221-H	
 -24	P+F SC3,5-G-N0	Schlitzinitiator Slot sensor A fessura	2	NAMUR NC	8.2V DC (EX) 5 - 25V DC (nEX)	-25 ... +100°C	ATEX 1GD cULus-cCSAus CCC (<=36V)	JEB2S24-H-IA	
 -236	P+F SJ3,5-SN	Schlitzinitiator Slot sensor A fessura	2	NAMUR NC	8.0V DC	-50 ... +100°C	ATEX 1GD cULus-cCSAus CCC (<=36V)	JEB2S236-H-IA	
 -225	P+F SJ3,5-S1N	Schlitzinitiator Slot sensor A fessura	2	NAMUR NO	8.0V DC	-25 ... +100°C	ATEX 1GD cULus-cCSAus CCC (<=36V)	JEB2S225-H-IA	

JAG-EASY-BOX HIGHLINE

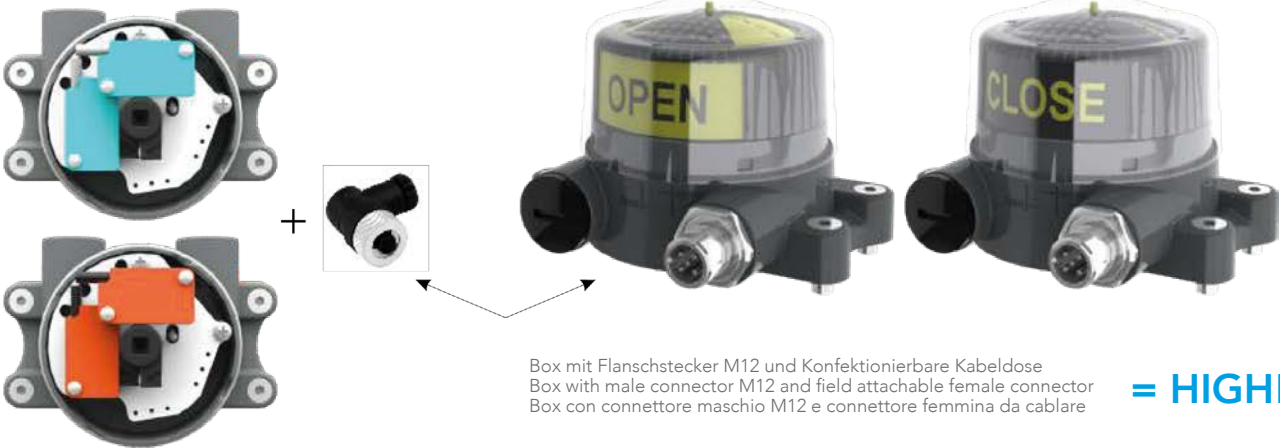

Box mit Flanschstecker M12 und Konfektionierbare Kabeldose
 Box with male connector M12 and field attachable female connector
 Box con connettore maschio M12 e connettore femmina da cablare

= HIGHLINE

ABMESSUNGEN

DIMENSIONS

DIMENSIONI

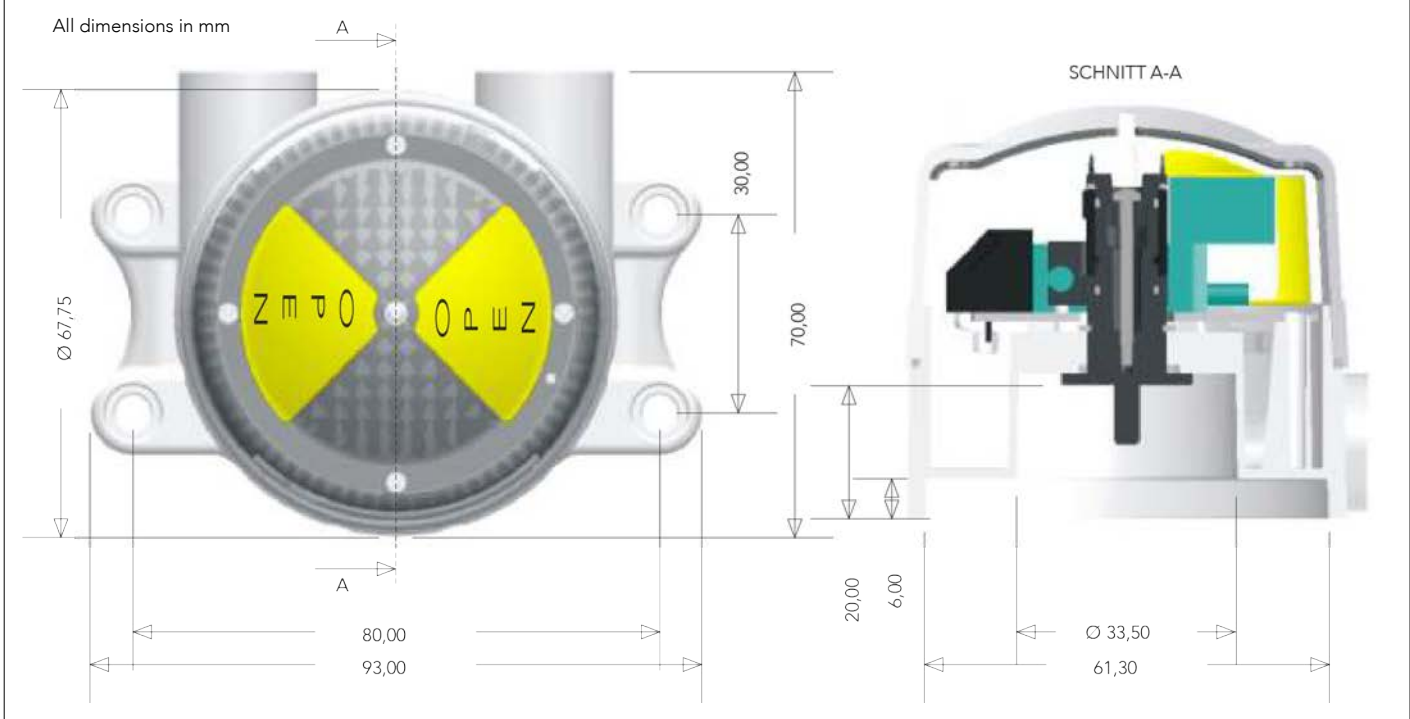

Weitere Endschalterboxen
 Further switchbox series
 Altri box finecorsa

